

CAUTION!
ONLY PROFESSIONALS EXPERIENCED AND QUALIFIED IN THE INSTALLATION OF SAFES SHOULD INSTALL THIS PRODUCT.

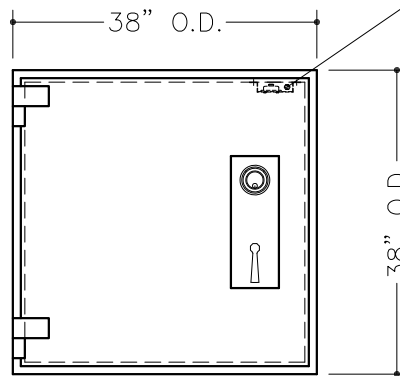
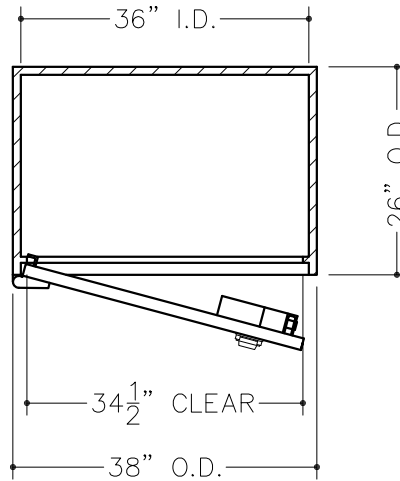
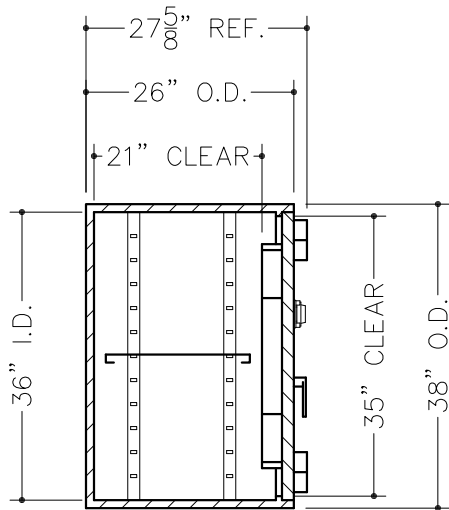

NOTES:

1. COMBINATION LOCK WITH SPY-PROOF, KEY LOCKING DIAL & RING.
2. BODY & DOOR ARE TL-15 PLATE SAFE CONSTRUCTION.
3. APPROXIMATE WEIGHT (SAFE ONLY): 1,150 LBS.
4. MODEL 981-1LS (LEFT SWING SHOWN)
 MODEL 981-1RS (RIGHT SWING OPPOSITE)
5. ONE ADJUSTABLE SHELF PER UNIT.
6. PREPARED FOR 2 OR 3 MOVEMENT TIME LOCK.
7. SET-UP TO RECEIVE 500 SERIES LOCKERS (18" DEEP).
 FOR LOCKER INSERT OPTIONS, SEE SHEET 2.

DO NOT SCALE

American Vault[®] Waco Texas

PRODUCT APPLICATION DRAWING
 MOD 981-1 TL-15 PLATE SAFE
 (OD: 38Hx38Wx26D)



SIZE	DWG NO	DATE	SHEET
A	20108	12.01.2023	1 OF 2

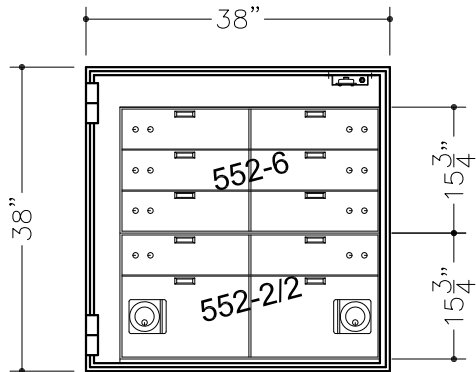

(8) 5x16 TELLER LOCKERS
(2) 10x16 CASH LOCKERS
(1) BASE (WELD-IN)

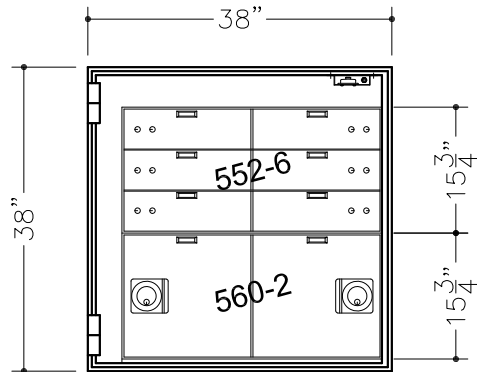

(6) 5x16 TELLER LOCKERS
(2) 15x16 CASH LOCKERS
(1) BASE (WELD-IN)

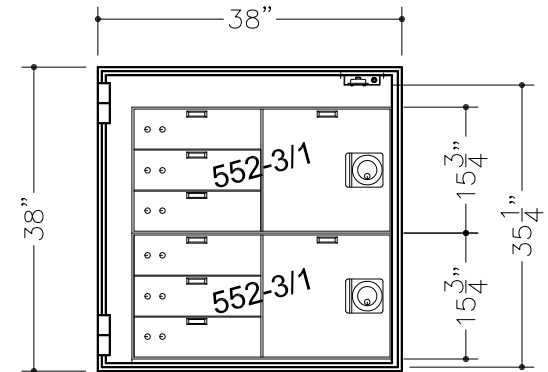

(6) 5x16 TELLER LOCKERS
(2) 15x16 CASH LOCKERS
(1) BASE (WELD-IN)

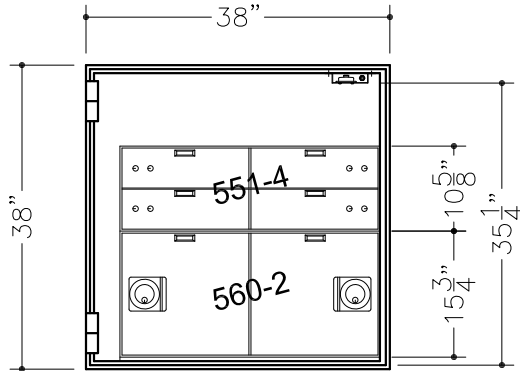

(4) 5x16 TELLER LOCKERS
(2) 15x16 CASH LOCKERS
(1) BASE (WELD-IN)

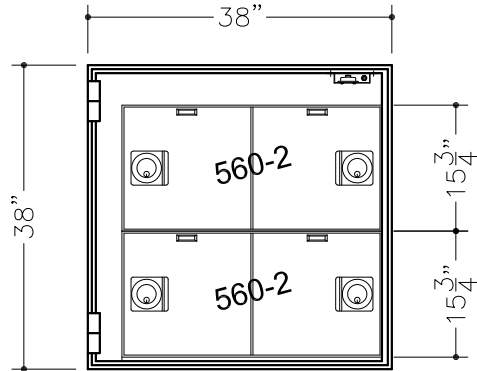

(4) 15x16 CASH LOCKERS
(1) BASE (WELD-IN)

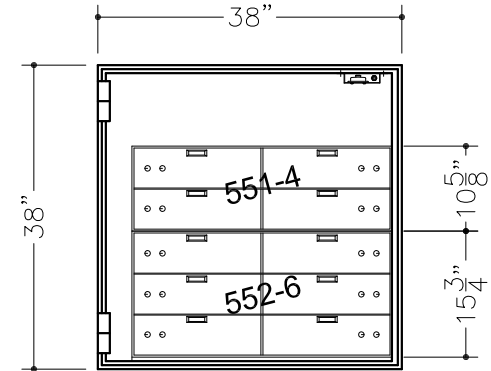

(10) 5x16 TELLER LOCKERS
(1) BASE (WELD-IN)

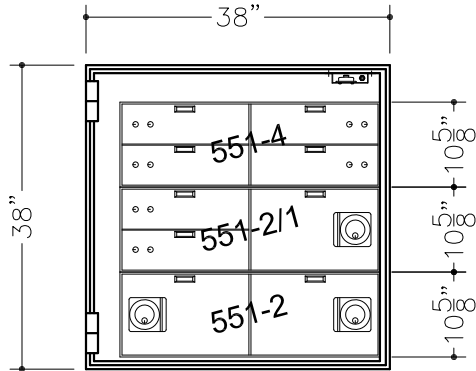

(6) 5x16 TELLER LOCKERS
(3) 10x16 CASH LOCKERS
(1) BASE (WELD-IN)

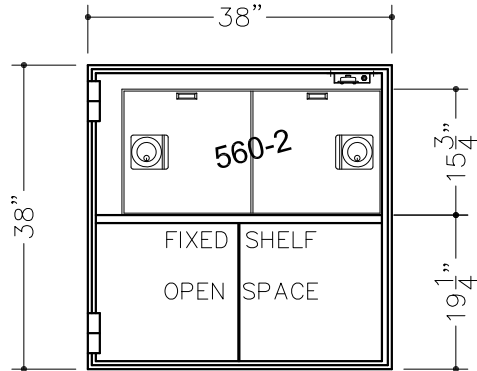

(2) 15x16 CASH LOCKERS
(1) FIXED SHELF (WELD-IN)



CAUTION!
ONLY PROFESSIONALS EXPERIENCED AND QUALIFIED IN
THE INSTALLATION OF SAFES SHOULD INSTALL THIS
DO NOT SCALE PRODUCT.

American
vault® Waco Texas

PRODUCT APPLICATION DRAWING
MOD 981-1 TL-15 PLATE SAFE
(OD: 38Hx38Wx26D)

SIZE	DWG NO	DATE	SHEET
A	20108	12.01.2023	2 OF 2