

ISLAND DETAIL

(OVERHEAD CONDUIT INSTALLATION)
NOTE: ISLAND IS TO BE SMOOTH AND LEVEL

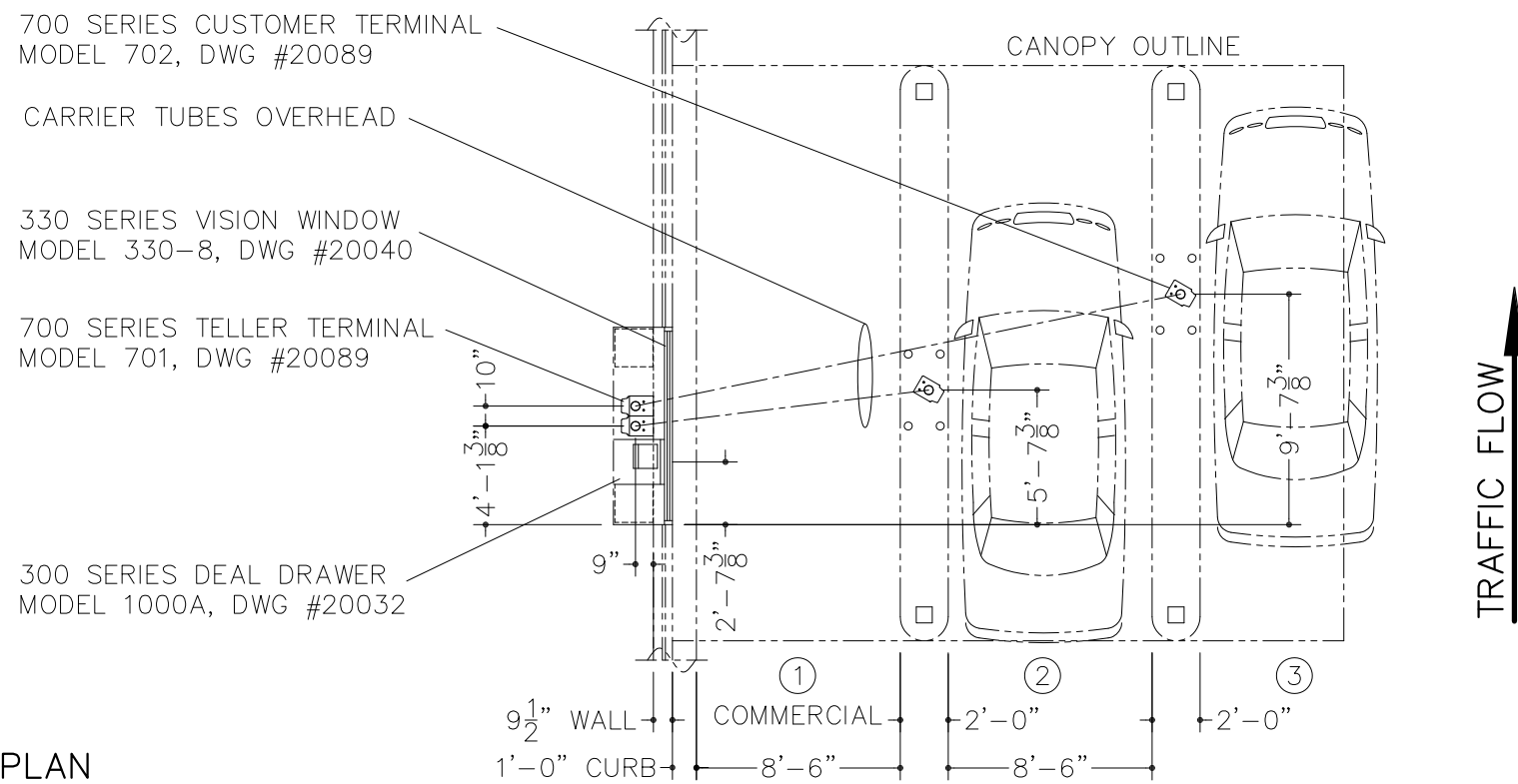

PLAN

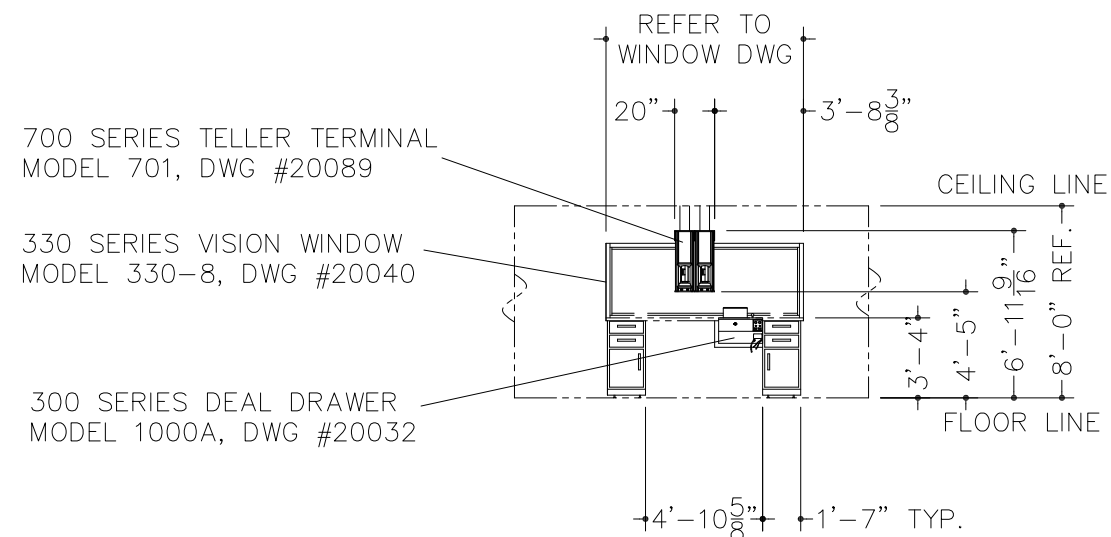

INTERIOR ELEVATION

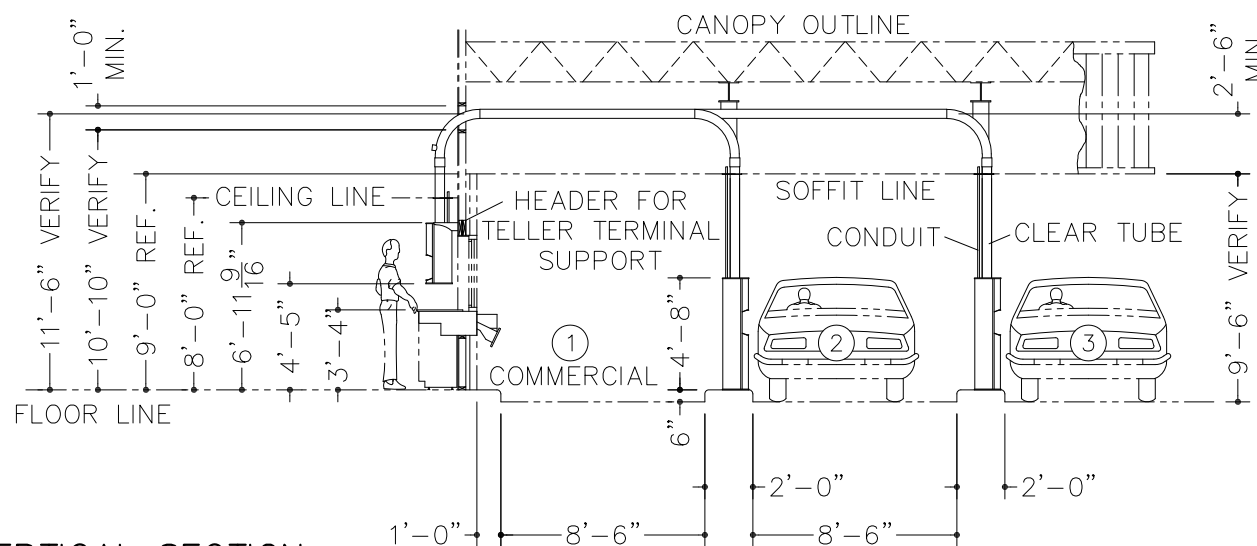

VERTICAL SECTION

- GENERAL NOTES:
1. ALL CONDUIT & PROPER ROUTING OF SUCH BY OTHERS.
 2. ALL PROTECTIVE BOLLARDS BY OTHERS.
 3. G.C. IS TO PROVIDE OPENINGS INTO BUILDING FOR ROUTING OF TUBES AND SUCH. G.C. IS TO COVER OPENINGS AFTER INSTALLATION.
 4. ELECTRICIAN IS TO PROPERLY LABEL ALL CIRCUITS.
 5. CANOPY CONSTRUCTION IS TO BE SUCH THAT IT ALLOWS FOR A STRAIGHT "TUBE RUN" FROM TELLER TERMINAL TO CUSTOMER TERMINAL WITHOUT OBSTRUCTIONS.
 6. CEILING AND CANOPY HEIGHTS SHOWN ARE FOR REFERENCE ONLY AND MAY VARY FROM DIMENSIONS SHOWN.

DO NOT SCALE



REFERENCE DRAWINGS	DRAWING NO.
330 SERIES VISION WINDOW, MODEL 330-8	20040
300 SERIES DEAL DRAWER, MODEL 1000A	20032
700 SERIES REMOTE TRANSACTION SYSTEM	20089

PRODUCT APPLICATION DRAWING DRIVE-UP TELLER FACILITY 2 TELLERS ON 3 LANES (8' WINDOW/2 RTS/DEAL DRAWER)			
SIZE	DWG NO	DATE	SHEET
B	20091	12.01.2023	1 OF 1